

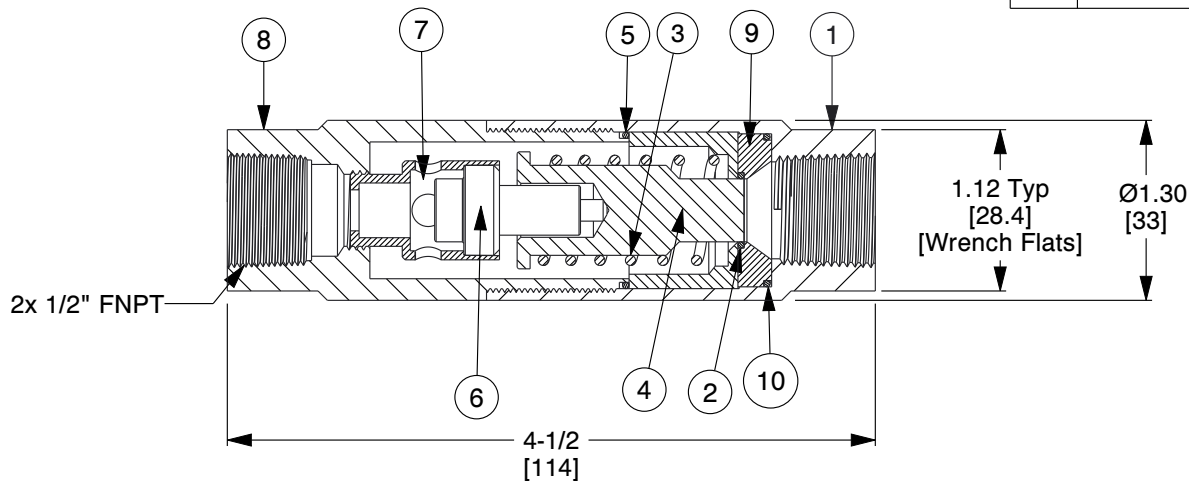

ITEM	DESCRIPTION	MATERIAL
1	BODY - HALF	300 Series SS
2	SEAT SEAL	FEP Encapsulated Viton
3	OPERATING SPRING	300 Series SS
4	RAM-TYPE PLUG	300 Series SS
5	BODY SEAL	EPDM
6	THERMAL ACTUATOR	300 Series SS
7	ACTUATOR CARRIER	300 Series SS
8	BODY - HALF	300 Series SS
9	SEAT INSERT	300 Series SS
10	SEAT INSERT SEAL	EPDM



NOTES:

1. Cv: 1.3.
2. PORT SIZE: C.
3. WEIGHT: 0.9 Lb (0.4 Kg).
4. MAXIMUM OPERATING PRESSURE: 150 PSIG (10.3 BAR).
5. MAXIMUM TEMPERATURE: 300°F (149°C).
6. REVERSE FLOW OPTION IS RATED 150 PSIG (10.3 BAR).
7. FULL OPEN/CLOSE TEMPERATURES: 35°F (1.7°C)/40°F (4.4°C).
8. 316 SS ALSO AVAILABLE.
9. A #20 MESH STRAINER IS RECOMMENDED.

FLUID SENSING
(REVERSE FLOW)
NOTE 6



COMPONENT	FREEZE PROTECTION VALVE
-----------	-------------------------



ThermOmegaTech, Inc.
353 Ivyland Road
Warminster, PA 18974-2205, USA
Ph: 215-798-5978

This file and any associated information and specifications are provided for reference and evaluation purposes only, and is subject to change without notice. ThermOmegaTech makes no representations, warranties or guarantees as to the appropriateness, accuracy, completeness, or suitability for any purpose, of the file, information or specifications. You are solely responsible for the use of the file, information or specifications.

This drawing is the property of ThermOmegaTech. It contains confidential, proprietary information that is ThermOmegaTech property. Do not disclose to or duplicate for others except as authorized by ThermOmegaTech.

SCALE

NTS

114-712100-035

1/2" HAT/FP-35-C-SS-RF-E (Fluid Sensing)

UNIT

INCH [MM]

SHEET

1 of 1