

4

3

2

1

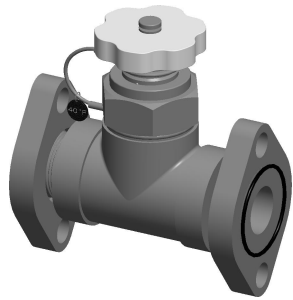

B

B

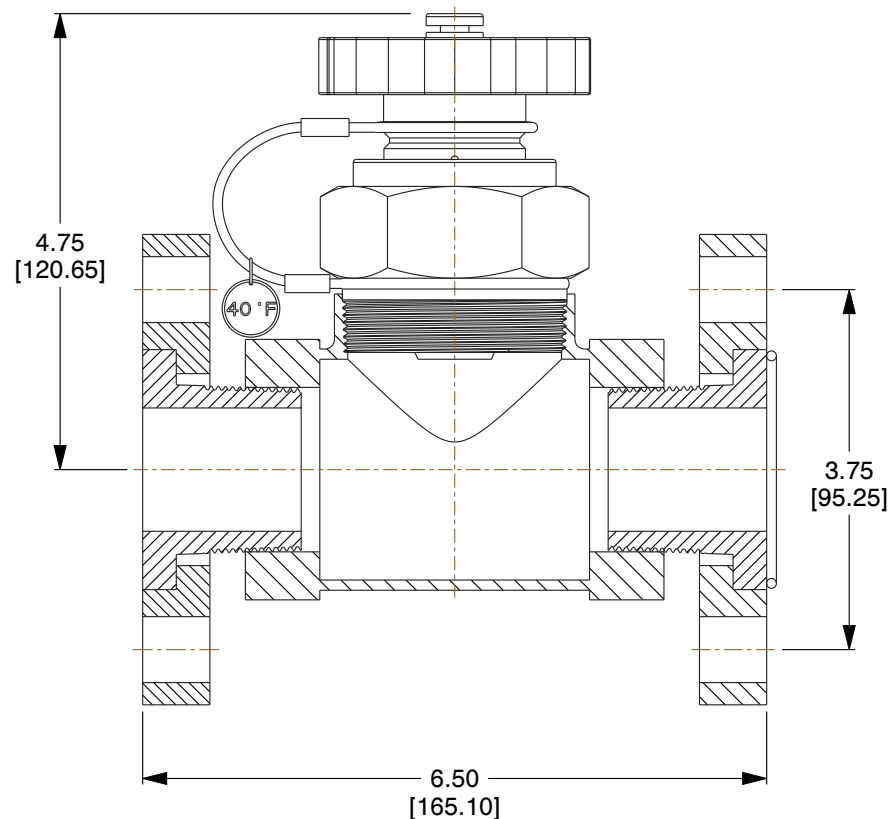

A

A

NOTES:

1. RELEASE TEMPERATURE: 40°F.
2. CARTRIDGE AND INSIDE OF HEX BODY MUST BE DRY BEFORE ASSEMBLY.
3. WARM THE CARTRIDGE TO AT LEAST 20°F ABOVE RELEASE TEMPERATURE BEFORE REINSTALLING.

COMPONENT	LOCOMOTIVE FREEZE PROTECTION
------------------	------------------------------



ThermOmegaTech, Inc.
353 Ivyland Road
Warminster, PA 18974-2205, USA
Ph: 215-798-5978

This file and any associated information and specifications are provided for reference and evaluation purposes only, and is subject to change without notice. ThermOmegaTech makes no representations, warranties or guarantees as to the appropriateness, accuracy, completeness, or suitability for any purpose, of the file, information or specifications. You are solely responsible for the use of the file, information or specifications.

This drawing is the property of ThermOmegaTech. It contains confidential, proprietary information that is ThermOmegaTech property. Do not disclose to or duplicate for others except as authorized by ThermOmegaTech.

SCALE

NTS

470-005000-000

MAGNUM TYPE-FL/FL-GX

UNIT

INCH [MM]

SHEET

1 of 1

4

3

2

1